



40223



Edition limitée

6160843 / 6160845

1



2



3



4



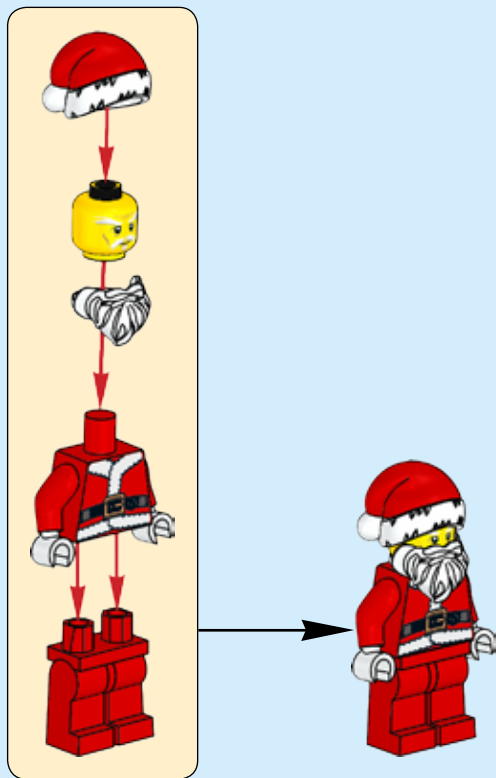

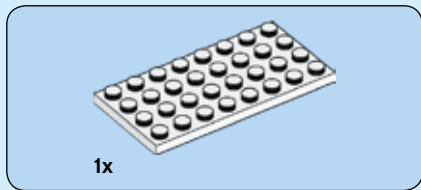

1

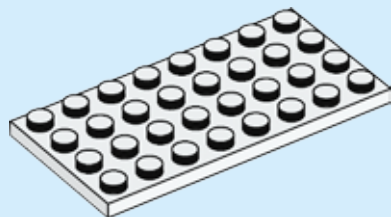

4

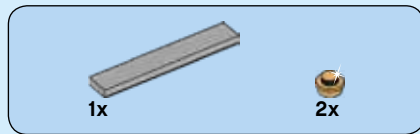

2

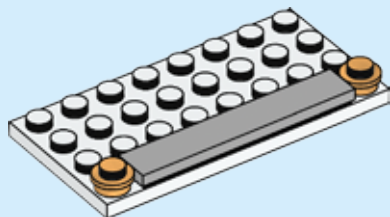

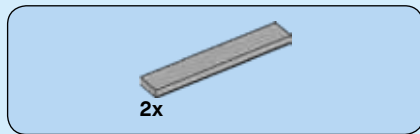

3

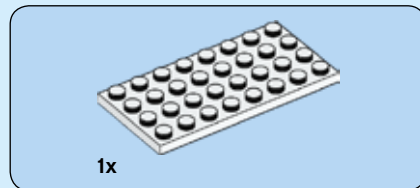
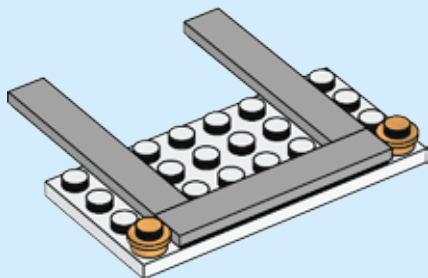

4

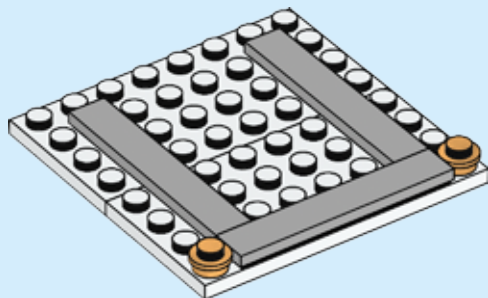



2x

5

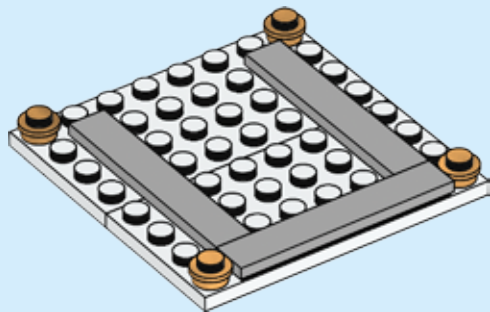

6



9x

6

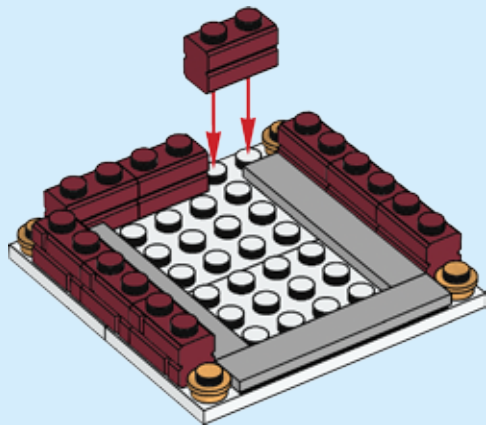



1x



2x

7

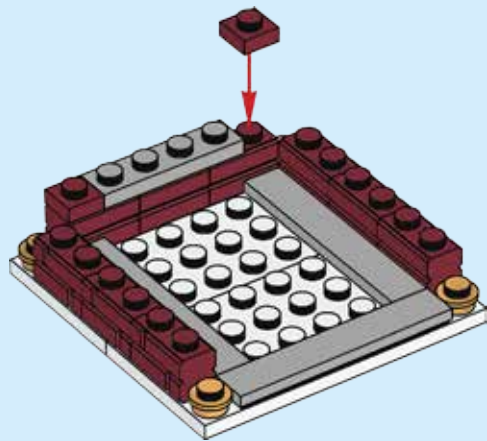

4x



4x

8

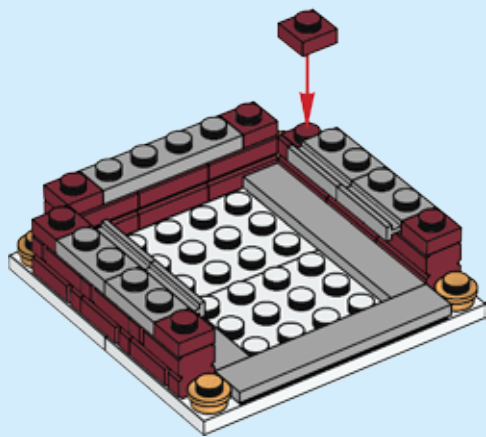



6x

9

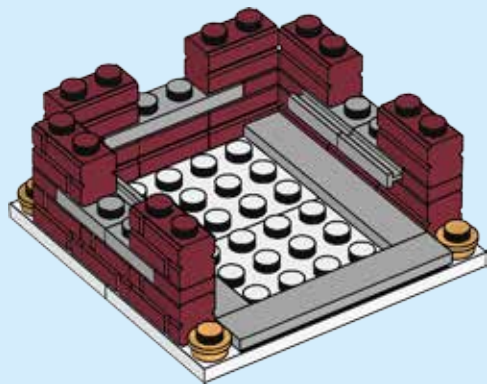

8



10

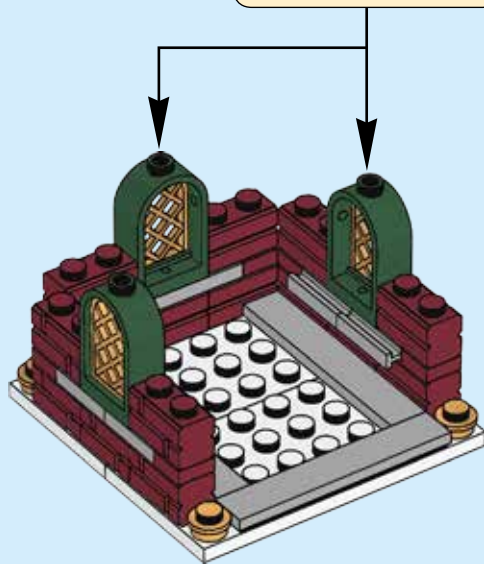
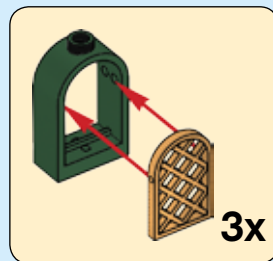



6x

11

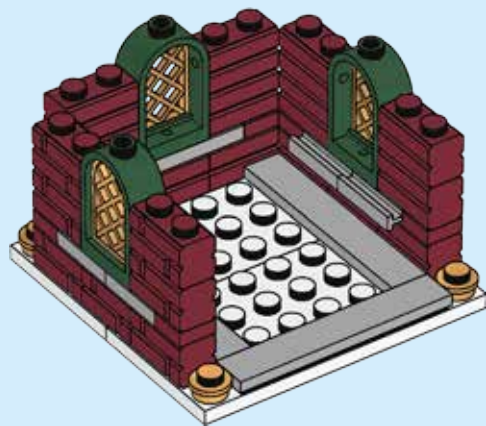



3x

12

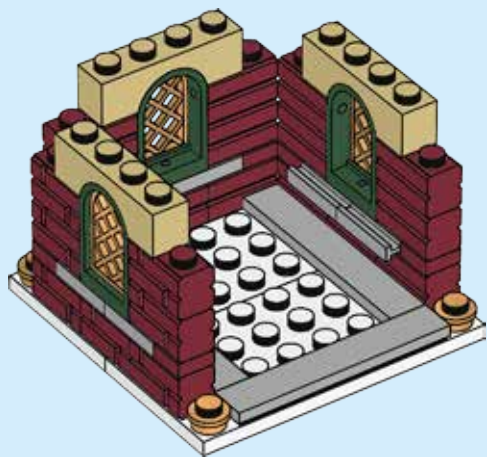

6x

13

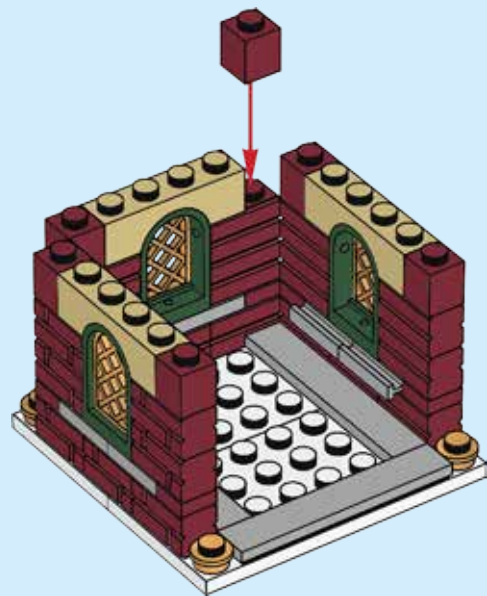



14

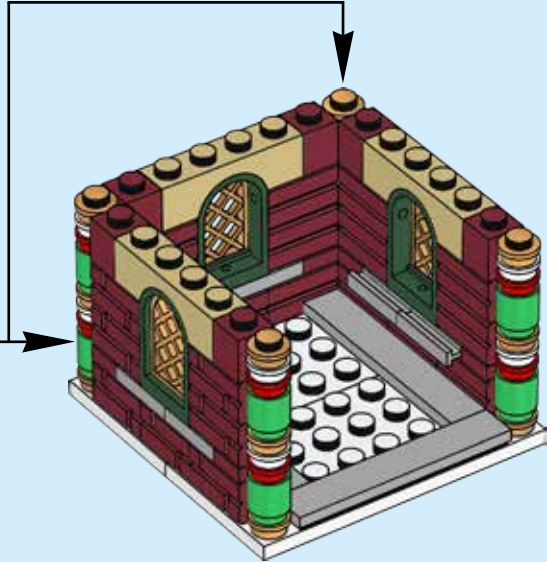
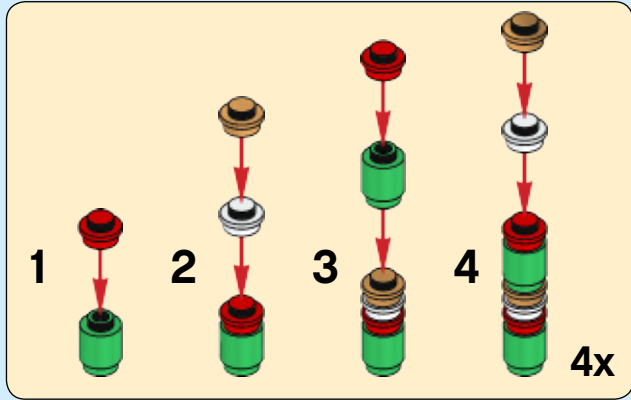

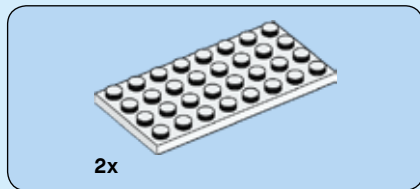

15

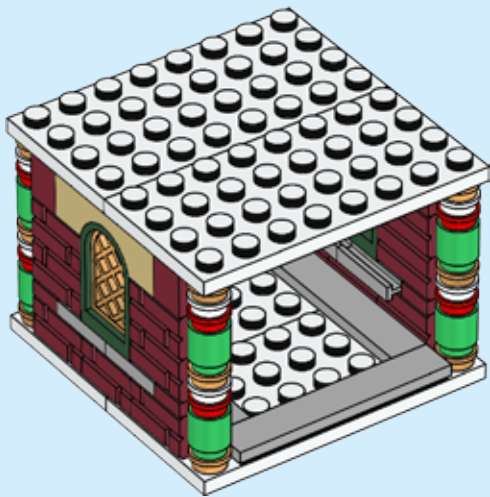



4x



4x

16

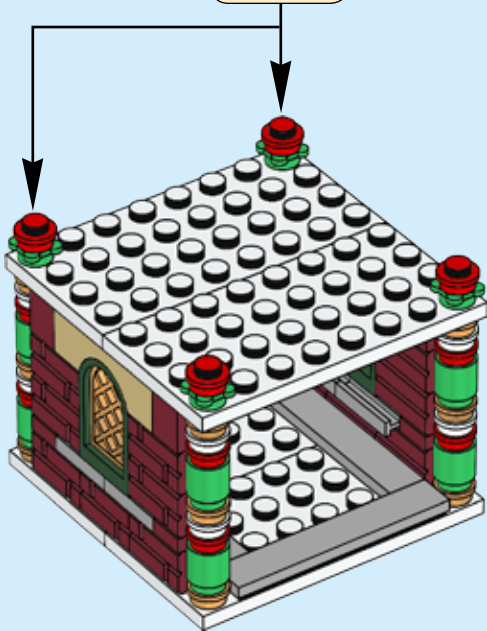
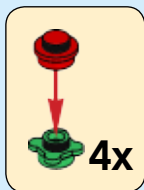



2x

17





2x



2x

18





2x



2x

19



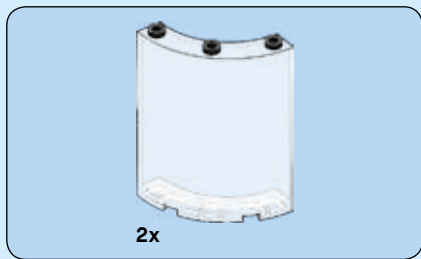

20

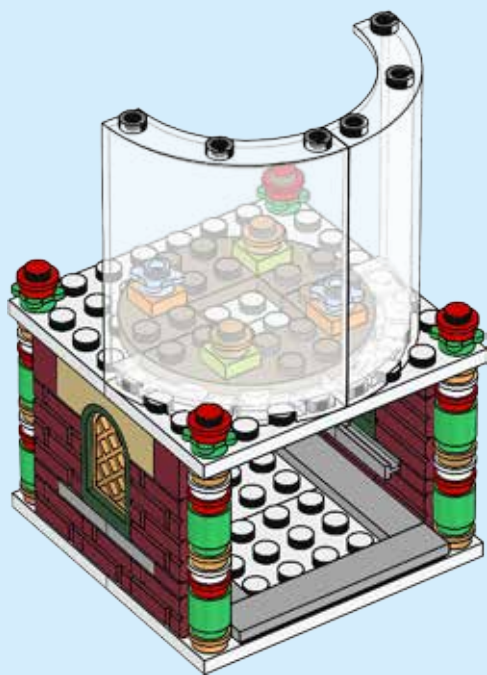

21





1x

22

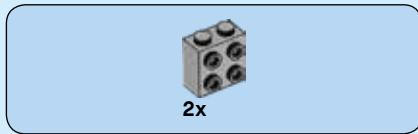

2x

23

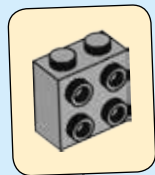



2x

24

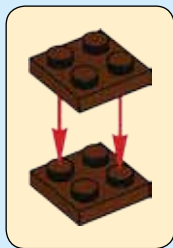

2x

25

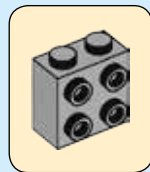



1x

26

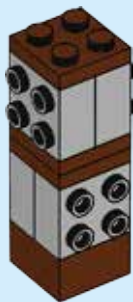

1x

27

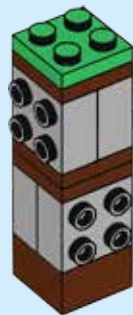



28

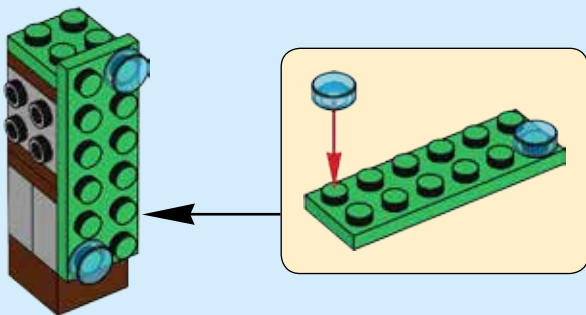



3x

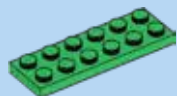

1x

29

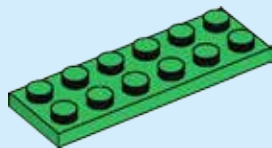

1x

30

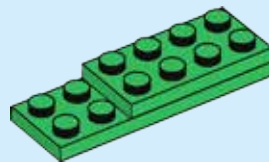



1x

31

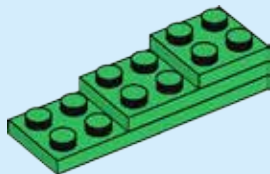

1x



1x



1x

32

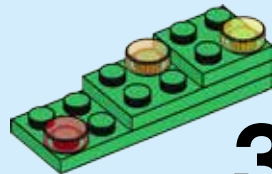

3x

33

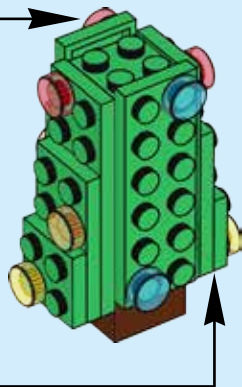

1x

34





1x

35

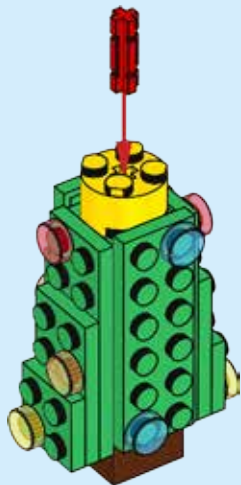

36



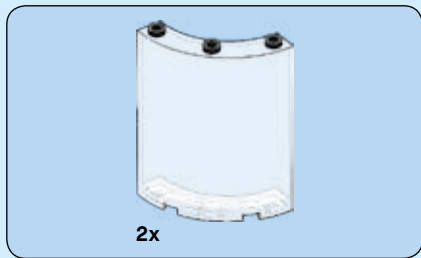

37





14x

38



14x



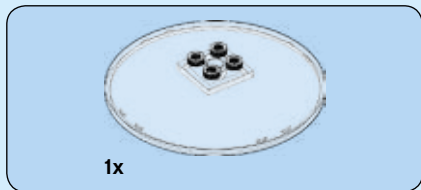

39





1x

40





4x

41





1x



4x

42

1



2



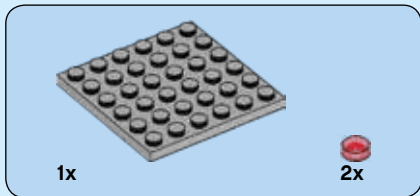

43

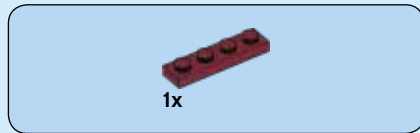
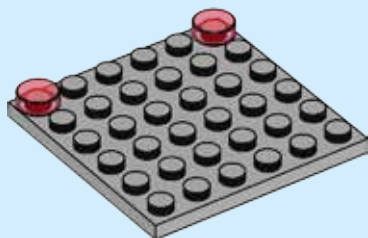

44

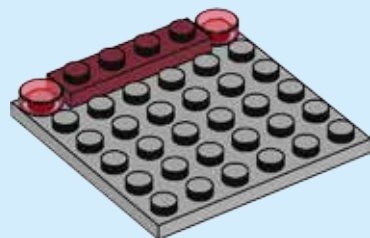

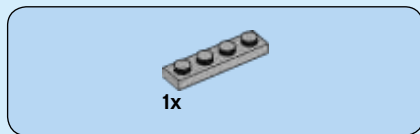

45

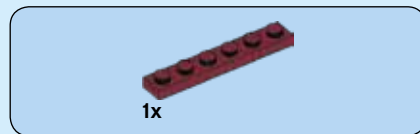
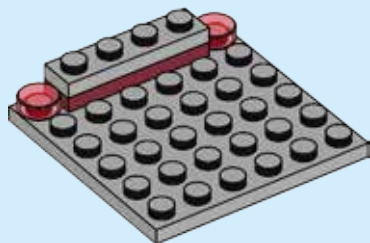

46

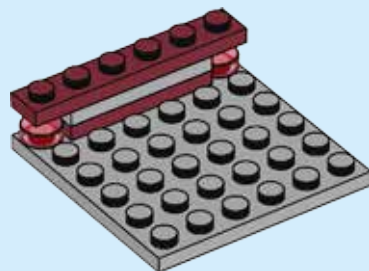

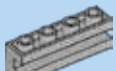

2x

47

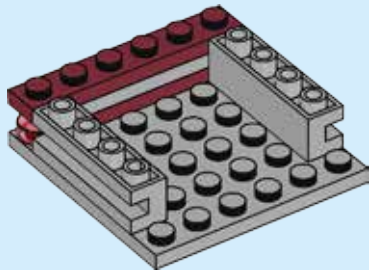

36



2x

48

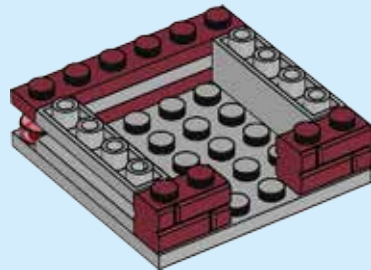

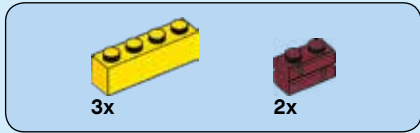

49

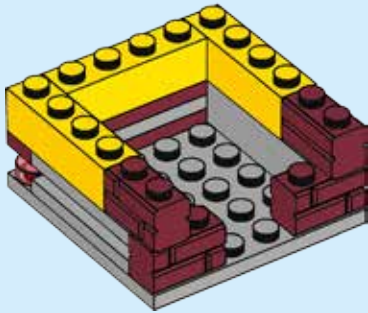

50

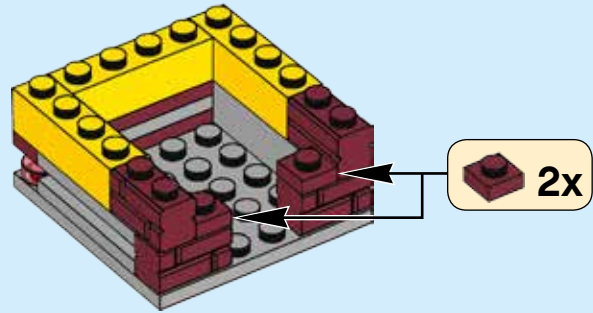



51

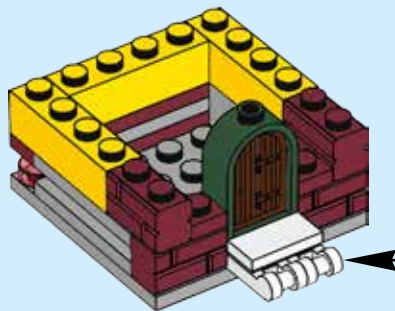
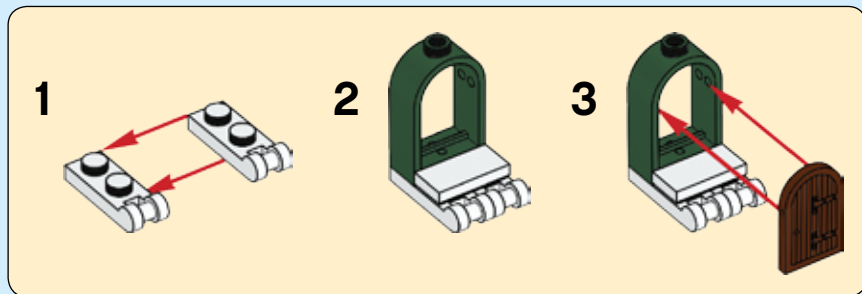



2x

52

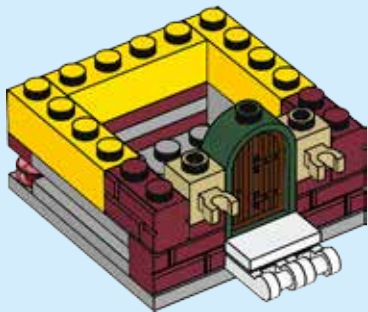

1x

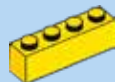

2x

53

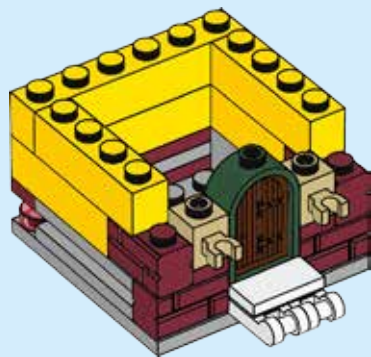



2x



1x

54

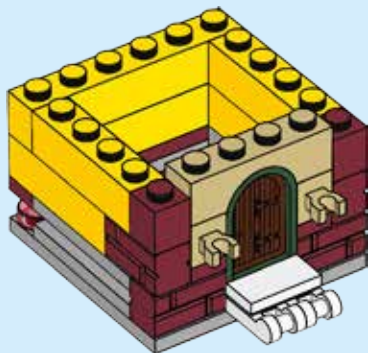

1x



2x

55

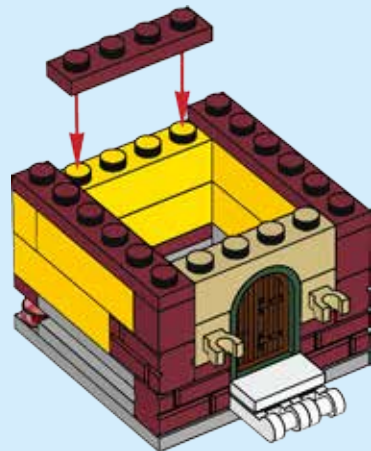

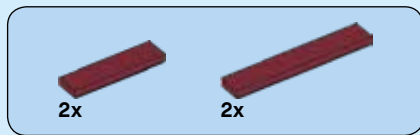

56

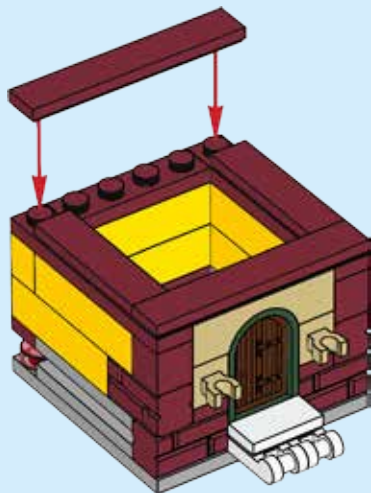

57

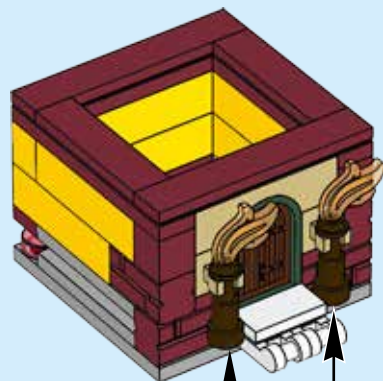
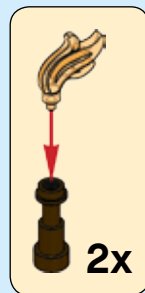

58





Customer Service

Kundenservice

Service Consommateurs

Servicio Al Consumidor

LEGO.com/service or dial



: 00800 5346 5555

: 1-800-422-5346



LEGO and the LEGO logo are trademarks of the/son
des marques de commerce du/son marcas registradas
de LEGO Group. ©2016 The LEGO Group.

6160843 / 6160845